

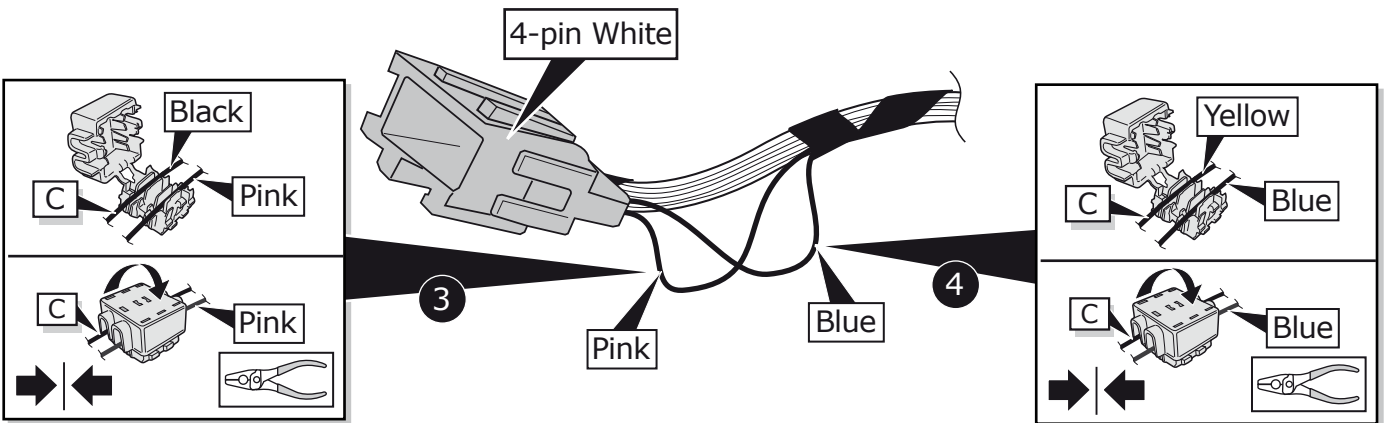

Addendum for HN-868-13U Civic (11) e:HEV Hatchback 10/2022 >>

INFO

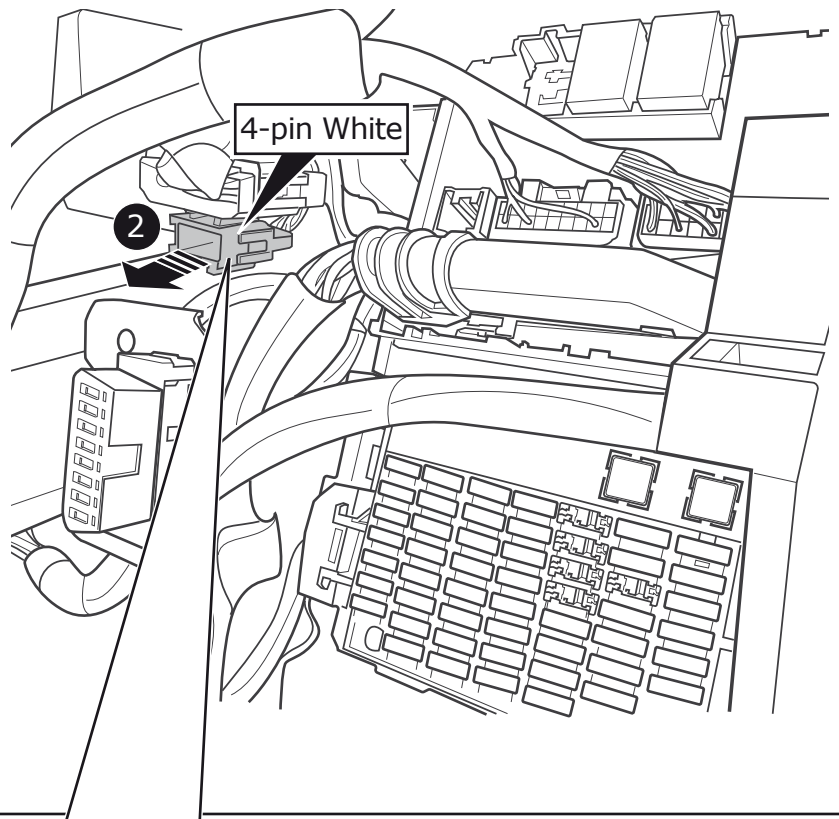
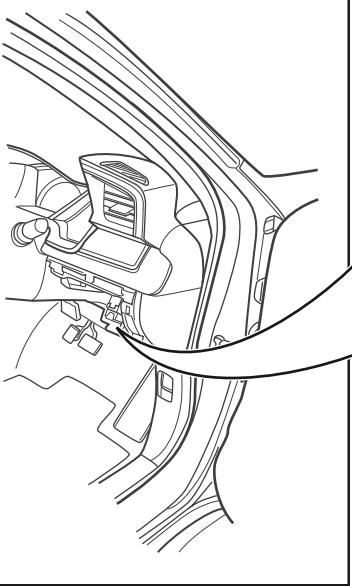
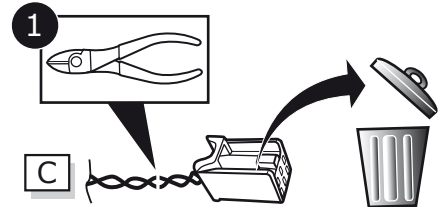
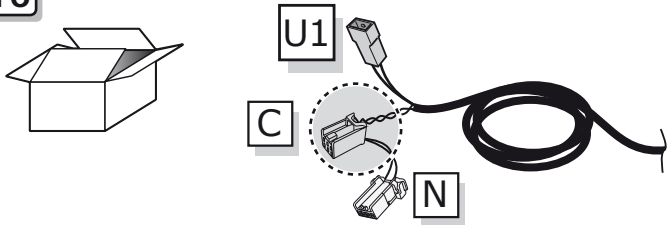
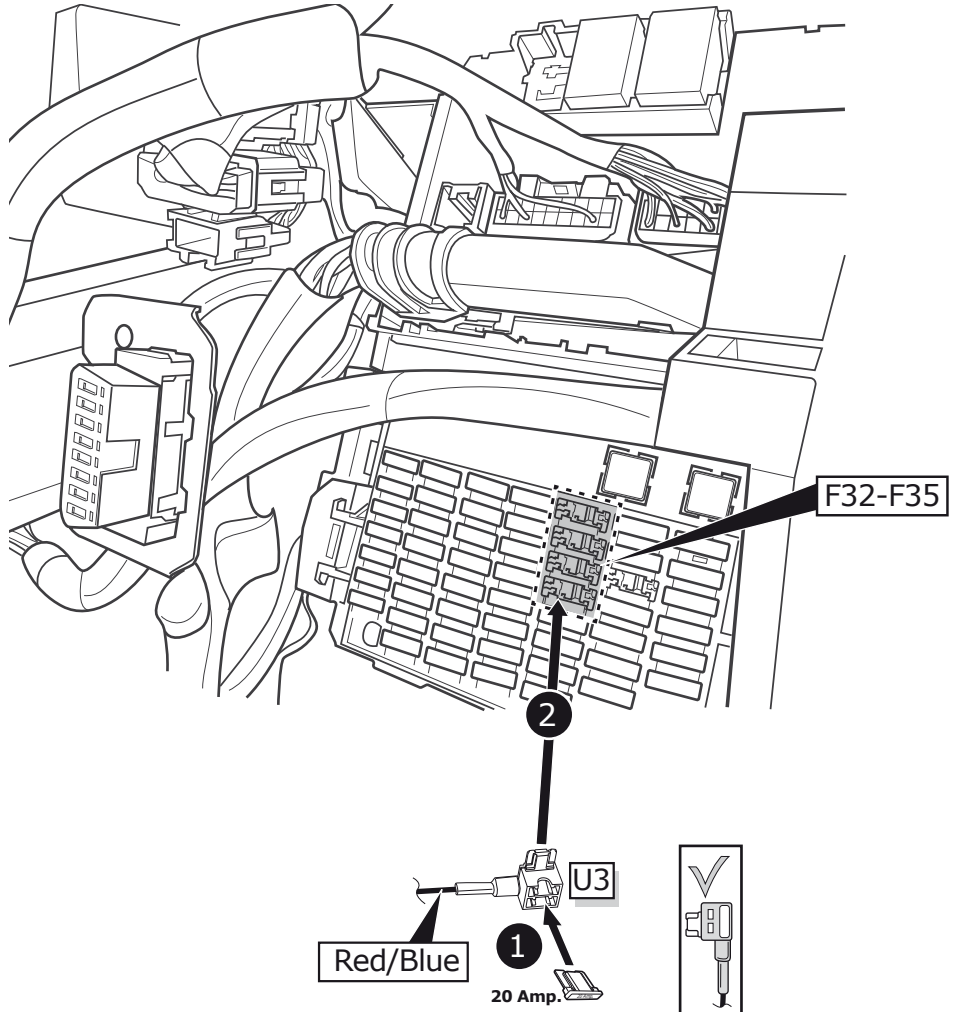
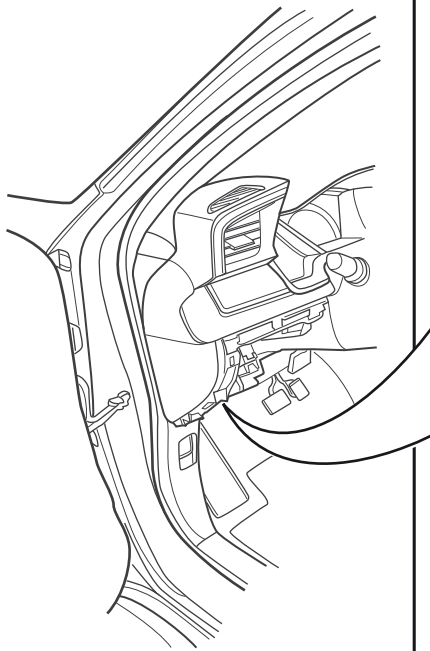

Civic (11)



 Important!
Please do not mount
the fuse tap and its
wiring output in
the other
direction!

